

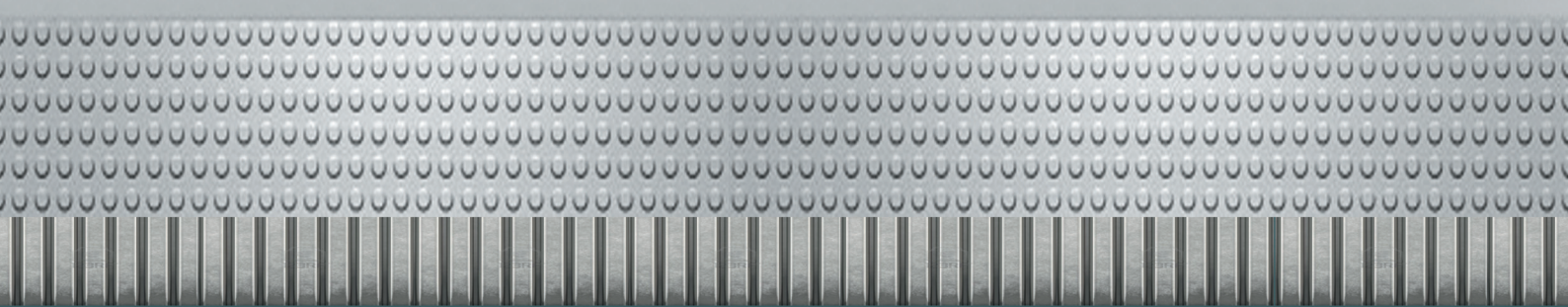

الشركة الوطنية للبناء والتسويق
National Building & Marketing Co.

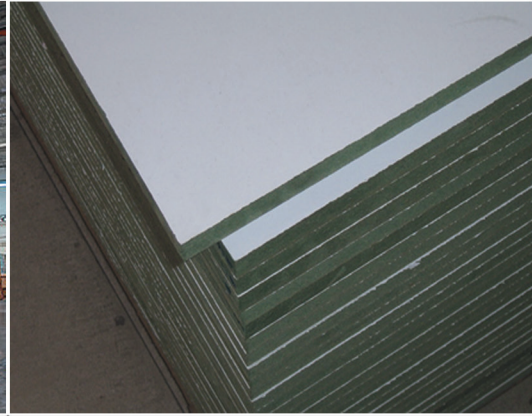

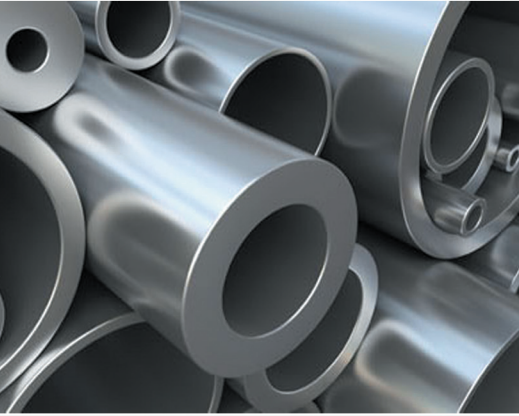

Film Faced Plywood

ألواح بلايود مدهون ١٨ ملم - ١٣ طبقة ١٢٢ سم × ٢٤٤ سم
ألواح بلايود مدهون ١٨ ملم - ١٣ طبقة ١٢٢ سم × ٢٤٤ سم اندونيسي



Ordinary Plywood بلاي وود عادي



Timber Wood

خشب

ألواح لتزانة نمساوي ٢,٥ × ١٠ × ٣ م.ط

ألواح لتزانة نمساوي ٢,٥ × ١٠ × ٤ م.ط

ألواح لتزانة نمساوي ٢,٥ × ١٢ × ٣ م.ط

ألواح لتزانة نمساوي ٢,٥ × ١٢ × ٤ م.ط



Scaffolding board خشب سقالة

خشب سقالات نمساوي ٤٠ × ٢٣٠ × ٤ م

خشب سقالات نمساوي ٥٠ × ٢٥٠ × ٤ م



Wood Blanket

مراييع

مراييع

مراييع نمساوي ٥ سم × ٣٥ × ٣ م.ط

مراييع نمساوي ٥ سم × ٣٥ × ٣ م.ط

مراييع نمساوي ٨ × ٨ × ٣ م.ط

مراييع نمساوي ٨ × ٨ × ٤ م.ط



Rebar Fabrication حديد مجفول

متوفر بجميع المقاسات



Wire mesh

شبكة أرضيات



Product	Dimensions
WIRE MESH	5.0mm x 2.0 x 5.0 – 15 x 15 cm
WIRE MESH	5.0mm x 2.0 x 5.0 – 20 x 20 cm
WIRE MESH	5.5mm x 2.0 x 5.0 – 15 x 15 cm
WIRE MESH	5.5mm x 2.0 x 5.0 – 20 x 20 cm
WIRE MESH	6.0mm x 2.0 x 5.0 – 20 x 20 cm
WIRE MESH	6.0mm x 2.0 x 5.0 – 15 x 15 cm
WIRE MESH	6.5mm x 2.0 x 5.0 – 15 x 15 cm
WIRE MESH	7.0mm x 2.0 x 5.0 – 15 x 15 cm
WIRE MESH	7.0mm x 2.0 x 5.0 – 20 x 20 cm
WIRE MESH	7.5mm x 2.0 x 5.0 – 15 x 15 cm
WIRE MESH	7.5mm x 2.0 x 5.0 – 20 x 20 cm
WIRE MESH	8.0mm x 2.0 x 5.0 – 15 x 15 cm
WIRE MESH	8.0mm x 2.0 x 5.0 – 20 x 20 cm
WIRE MESH	8.5mm x 2.0 x 5.0 – 15 x 15 cm
WIRE MESH	8.5mm x 2.0 x 5.0 – 20 x 20 cm
WIRE MESH	9.0mm x 2.0 x 5.0 – 20 x 20 cm
WIRE MESH	10.0mm x 2.0 x 5.0 – 15 x 15 cm
WIRE MESH	10.0mm x 2.0 x 5.0 – 20 x 20 cm



Rebar steel

حديد تسليح

Epoxy steel bar

حديد الأوبوكسي



حديد مجدول سابق - إتفاق

حديد تسليح مجدول ٨ ملم
حديد تسليح مجدول ١٠ ملم
حديد تسليح مجدول ١٢ ملم
حديد تسليح مجدول ١٤ ملم
حديد تسليح مجدول ١٦ ملم
حديد تسليح مجدول ١٨ ملم
حديد تسليح مجدول ٢٠ ملم
حديد تسليح مجدول ٢٥ ملم



Steel Props

دعامات

Steel Props are infinitely reusable product used to support formwork shuttering. Their telescopic function allows speedy erection and dismantling without tools and it has no loose parts to be mislaid or lost.



Scaffolding

سقالات

Universal Scaffolding. Standard unit consists of two verticals and one horizontal cross bar

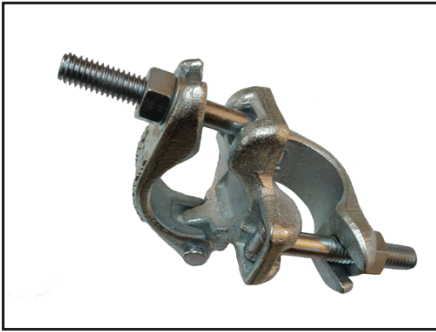

Double Coupler

رابط سقالة

Scaffolding fittings by Strongforge - Double Coupler. All made to European Quality Standard EN74B

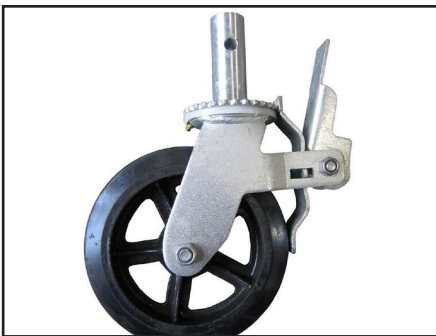

Scaffold-caster-wheel

كفريات عجل

8 inch caster wheel enables you to easily move scaffolding exactly where you need it and locks into place for optimum stability and reliability.

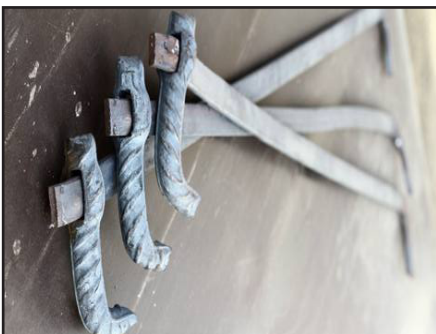

Shuttering Clamp

قلمط

It s a softy still in regular thickness 8 mm. Lock thickness between 2025- mm.



Water Stop

دعامات

for seal expansion joint in concrete structure against water penetratio.



PVC water stop splicing

Universal Scaffolding. Standard unit consists of two verticals and one horizontal cross bar

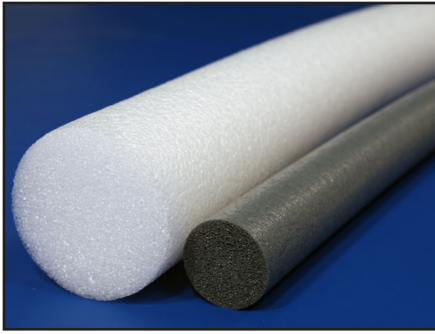

Backup Rod

رابط سقالة

closed-cell polyethylene foam backer rod for use as a backing material for elastomeric and other cold applied



Sika-flex Sealant

كفريات عجل

8 inch caster wheel enables you to easily move scaffolding exactly where you need it and locks into place for optimum stability and reliability.



Saaf 11 - 1200

قلم

SAAFSEAL is non-flammable, produce no harmful fumes, dries quickly and remains flexible after it has cured



Wheel Spacer

بسكويت

Plastic wheel spacers are used for vertical and horizontal reinforcements and it gives the required distance Between formwork and rebar's. Wheel spacers are most extensively used for precast and on site concrete applications.



Chair spacer

The most popular spacer for use in horizontal applications such as suspended slabs, beams etc.

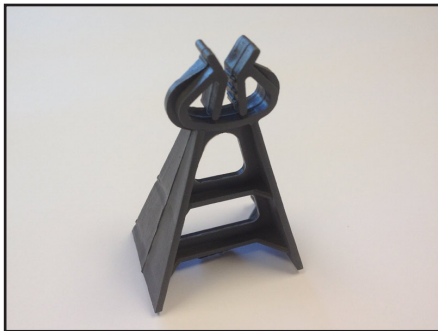

Clip Spacer

A lightweight range designed for the precaster to take bars up to 16mm diameter. Can be fixed onto steel horizontally and vertically.



PVC Pipe

مواسير بي في سي

We are offering our customers a wide range of PVC Pipes, which are available in various sizes and specifications. Our PVC Pipes are made from excellent quality raw materials and it can be availed at industrial leading price.

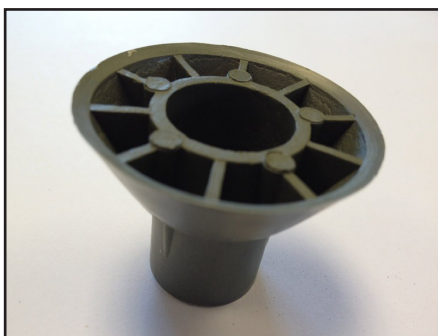

PVC Cone

كون بي في سي

To be used with 15mm Tie Bar as part of the formwork system. The Tie Bar is inserted through the Tie Bar Sleeving and cone. The Tie Bolt Cones can be removed once striking of the formwork has taken place and the hole filled with the Formplug.

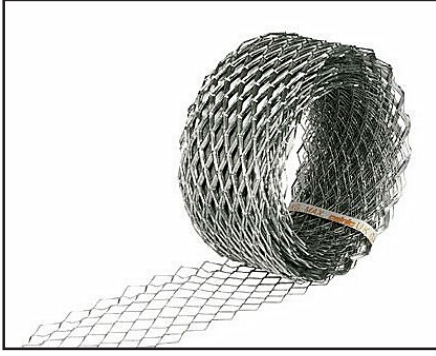

Block Reinforcement Mesh

Low Carbon Steel Wire and Galvanized Wire

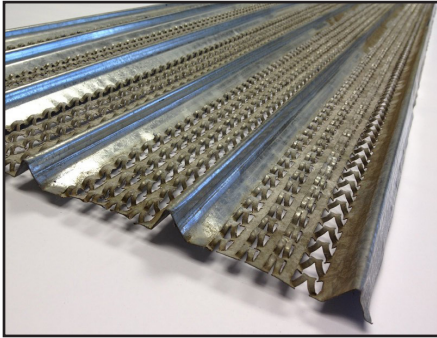

Hy-Rib

The exquisite range of Hy-Rib Lath we offer is produced from hot-dipped galvanized steel sheet. Hy-Rib Lath is applied to the concrete structure to offer better stress strength and help form free shapes.



Rib-Lath

رابط سقالة

is intended for horizontal applications with its seven longitudinal ribs, each 38/ inch deep and eight small flat ribs to provide additional rigidity. The herringbone mesh pattern provides excellent bonding of the stucco to the lath for ceiling and soffit installations.



Block Ladder Mesh

سلم بلوك

It has the continuous lengths of joint reinforcement that are embedded into the horizontal mortar joints of masonry walls. Joint reinforcement has long proven to be necessary for superior performance of masonry wall construction.

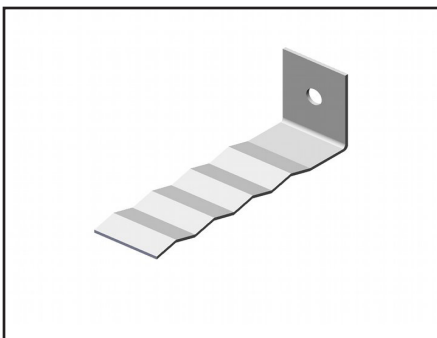

Corrugated angle

زاوية بلوك

Corrugated Galvanized Roofing. Rebar & Remesh. Ornamental Iron



Nylon Roll

بلاستيك نايلون

This heavy duty clear polythene sheet is ideal as a super heavy weight dust cover during decorating, building or daily work

رولات نايلون

رول نايلون ٢٠ ميكرون إلى ٣٥٠ ميكرون

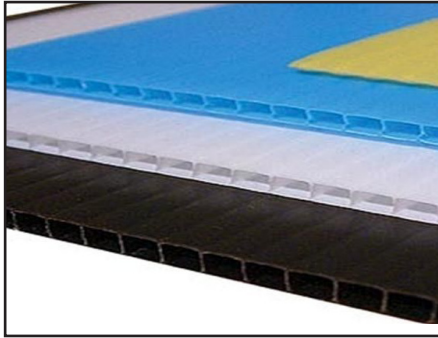

Protection board

ألواح حماية

The pp Flute Boards or Polypropylene Flute Sheets have doubled wall profile extrusion that is jointed by series of vertical ribs.



Geotextile-Fabric

ألياف

It is common practice to use needle-punched nonwoven geotextiles as puncture protection for geomembranes against sharp objects like gravel or stones in either the soil above or the underlying soil/rock below.



Fiber Mesh

ألياف

Fiberglass Mesh widely used in Reinforcing light wallboard, internal and external wall, building component



PVC Chamfer

PVC Chamfer designed to form chamfered corners in both columns and beams and Expansion joint on Walls



Tie Rod

تي رود

Our formwork fasten tie rod high high strength, has been adopted by Beijing Olympic venues, nuclear and hydro power stations.

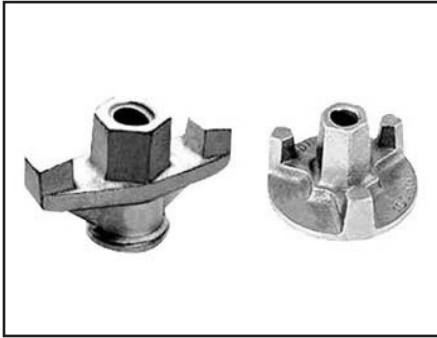

Wing Nut

صامولة

wing nut DIN315 m6 clip nuts screws bolt threaded insert m6 m4



Water Barrier Flanged

Efficient cast in-situ Tie Bar water barrier for use in water retaining structures.

Plastic reducer ensures a neat, clean fit with the Tie Bar Tubing when used with the flanged water barrier.



Washer Plate

A variety of Formwork Accessories available including: Dywidag Wing Nut, Dywidag Threadbar, Dywidag Flat Washer, Dywidag Plate Washer, Tie Sleeve, Cone, Formwork Plugs & Tie Plugs and Mould Oil.



Rapid Clamped

زرقيه

The Rapid Product Mix Rapid Clamps (Pty) Ltd acts as a distributor of Stainless Steel Pipe Repair Clamps and related Pipe Fittings from Cascade,

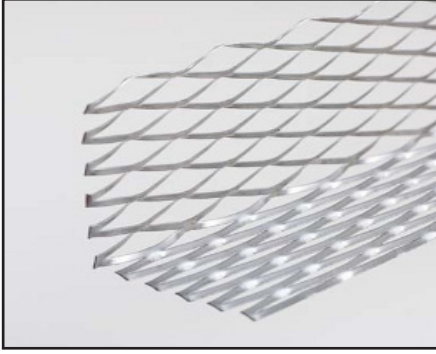

Angle Beads

شبكة لياسة

Angle bead (corner beads) may form straight side on the edge line of plaster project to fight break or chap and strengthen the most fragile part of the plaster. Its wing may enter the plaster in any edge line strongly.

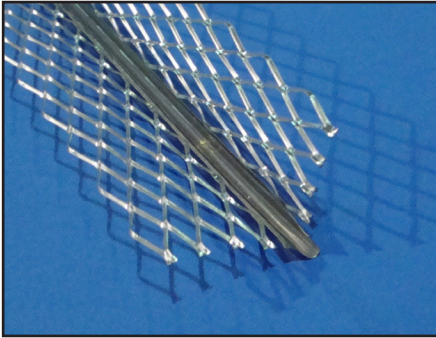

Corner mesh

زاوية لياسة

General purpose reinforcement strips used in plaster where cracking is likely to occur. Corner mesh Ref. 210 reinforces plaster at internal angles and will reduce the likelihood of cracking due to shrinkage, Nominal angle size = 75 x 75 x 30 m coils.

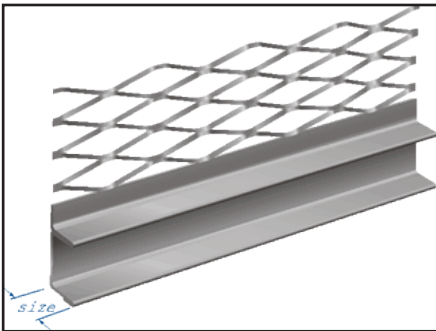

Architrave Beads

It protects corner plastering against cracks and chipping at the same time provide a straight arris for better finishing.

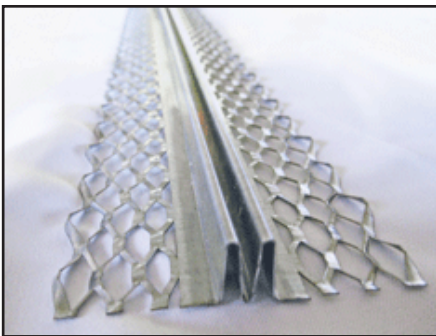

Control Joint Beads

Relieves the stresses of expansion and contraction in large plastered areas.

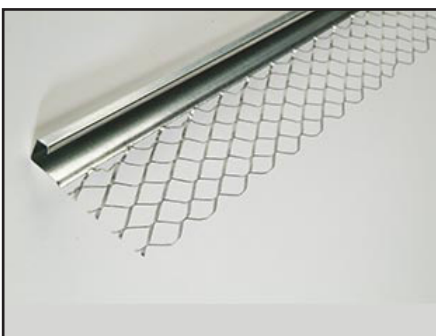

Plaster stop Beads

Thistle bead used for solid plastering. A galvanised steel bead with expanded wings for finishing and reinforcing plaster edges.



Concrete nail

مسامير صلب

مسمار صلب

مسمار صلب ٢,٥ سم

مسمار صلب ٣ سم

مسمار صلب ٥ سم

مسمار صلب ٦ سم

مسمار صلب ٧ سم

مسمار صلب ١٠ سم



Common Nails

مسامير عادي

مسمار خشابي

مسمار خشابي الفاخر ٦ سم

مسمار خشابي الفاخر ٥ سم

مسمار خشابي الفاخر ٧ سم

مسمار خشابي الفاخر ١٠ سم



Tie Wire

سلك تربيطة حديد

سلك تربيطة

سلك تربيطة عيار ٢٢ وزن ٧ - ٨ كجم



PVC Tie Wire سلك تربيطة بي في سي

سلك تربيطة

سلك تربيطة عيار ٢٢ وزن ٧ - ٨ كجم



Jute Cloth

خيش



Derma bit

ديرمبيت

used as protection over water proofing on foundation walls , bridges



Awazel

عوازل

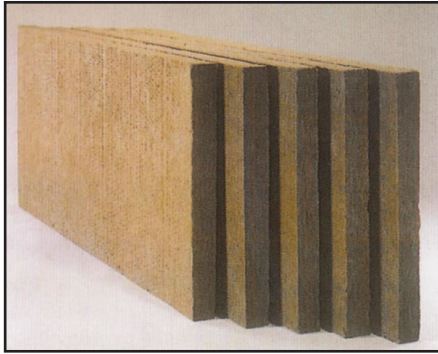

Rockwool sheet insulation

صوف صخري ألواح



Filler Glass

صوف زجاجي



Filler Board

ألواح سولتكس

لوح سولتكس ١٠ ملم

لوح سولتكس ١٢ ملم

لوح سولتكس ١٨ ملم

لوح سولتكس ٢٥ ملم



Wall Insulation

صوف صخري ألواح

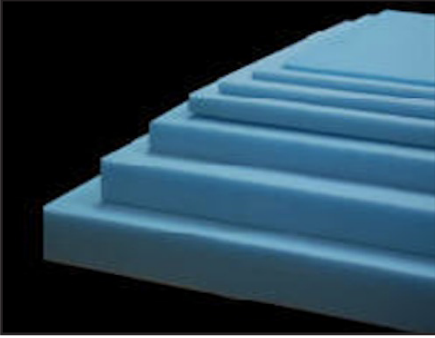

Floor, Roof insulation

عزل حراري للأسقف والأرضيات



Rockwool Roll blanket

صوف صخري رولات



Rockwool Pipe Insulation

صوف صخري مواسير

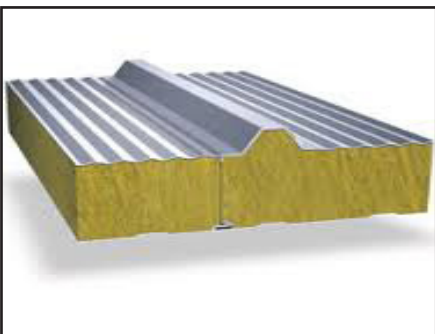

Sandwich Panel



Safety Shoe

High quality genuine leather
PU outsole steel toe industrial
safety shoes



Safety Eyewear

New Labour Protection Welding
Goggles Working Protective
Sunglasses Safety Eyewear



Respirator

20PCS/box 3M original 8210
dust masks particles pm2.5
N95 masks working respirator
Welded strap attachment



Fall Protection

BLUE EAGLE Lanying KA91H
big hook full body fall protection
harness high-altitude operations



Safety Helmet

Essential High Quality Safety Helmet Breathable And High Strength Protective Helmet Head Up Construction



Working Gloves

Sheepskin driver mechanic gloves / fine welding welding glove leather working gloves



Work Wear

Long-sleeve workwear set Men protective clothing work clothes worker clothes construction workers uniform



Reflective Safety wear

Reflective Safety Vest Yellow w/ 2» Strips for Construction Traffic & Warehouse & Night Activity & Cycling
Back to product details